

1938 LARGE LINCOLN LOG AND TIMBER DESIGN BOOK

For 3/4-in. Logs and Timbers

9 ³/₄ in. wide by 13 in. tall

4 Numbered Pages

LARGE LINCOLN LOG AND TIMBER DESIGN BOOK

ONLY LINCOLN LOGS AND TIMBERS HAVE THESE EXCLUSIVE AND PATENTED FEATURES

DESIGN BOOK COPYRIGHT-1938

J. L. WRIGHT, INC.

NAME REGISTERED AUGUST 28, 1923

U. S. PATENTS 1,351,086 AND 2,012,160

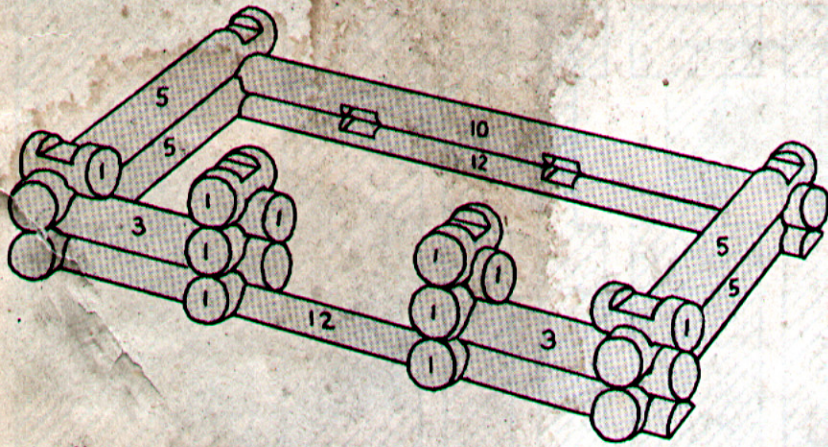

★ LINCOLN LOG FOUNDATION PLAN SHOWN ABOVE

How to Start Your Building

1st. Pick out the half Logs No. 12. Flat side down, round side up, these half Logs are used to form the front and back of the base of the building.

2nd. Connect the ends of the half Logs with two No. 5 Logs.

3rd. Lay a No. 10 Log over No. 12 at the rear.

4th. Place a No. 1 Log in each of the middle notches of No. 12 at the front and connect them with the No. 5 Logs by two No. 3 Logs.

5th. Follow the numbers shown in the diagram; then read about the other construction features illustrated on this Page and you will be ready to build the structures shown on Pages 3 and 4. Before long you will be designing your own buildings. Rubber bands may be used to hold them together, if desired.

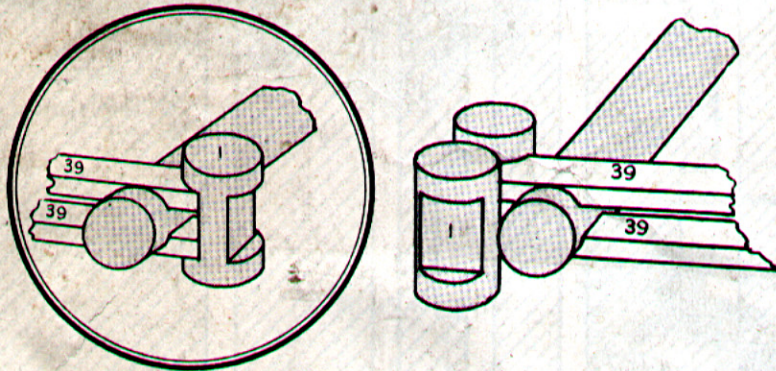

★ A NEW DEVELOPMENT IN LINCOLN LOG CONSTRUCTION is the use of the narrow roof planks No. 39 as beams or girders by placing two of the planks in the opposite notches of a Log, as shown in the above illustrations, and locking the ends together with No. 1 or other Logs. The planks and Logs thus locked together may be placed either vertically or horizontally to build towers, bridges, fences, platforms, etc., as illustrated within. When both ends of a pair of planks are thus locked together, the elasticity of the planks provides enough tension to hold the pieces securely.

★ INTRODUCTION

The building designs shown herein are simple and easy to understand but they represent merely a few suggestions. The possible combinations of Lincoln Logs and Timbers are without end as they are designed on a multiple unit system that is based on a diameter of $\frac{3}{4}$ ". The Logs and Timbers are interlocking at windows, doors and corners to make buildings more solid. The identifying numbers of the Logs, Timbers and other pieces are given on Page 2, actual sizes being shown.

Lincoln Timbers are identical with Large Lincoln Logs except that they are square instead of round. The Logs and Timbers are interchangeable and wherever the word "Log" is used in these instructions, the word "Timber" may be substituted.

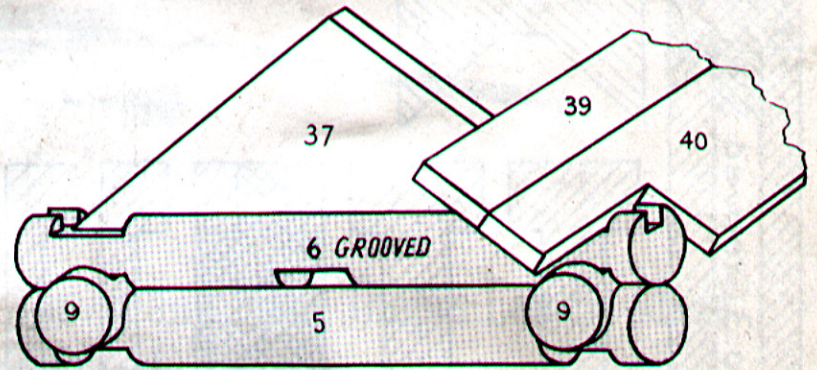

★ GABLE AND ROOF CONSTRUCTION

The new patented Lincoln Log gable and roof is illustrated above. When the sides and ends of your building have reached the desired height, place a grooved Log No. 6 on the uppermost Logs at the ends of the building to receive the triangular gable No. 37. Then place the bottom roof planks No. 40 on the lower corners of the gable and against the outer edges of the notches in the slotted Logs, as shown in the diagram, and place other roof planks No. 39 above them on the gables to complete the roof.

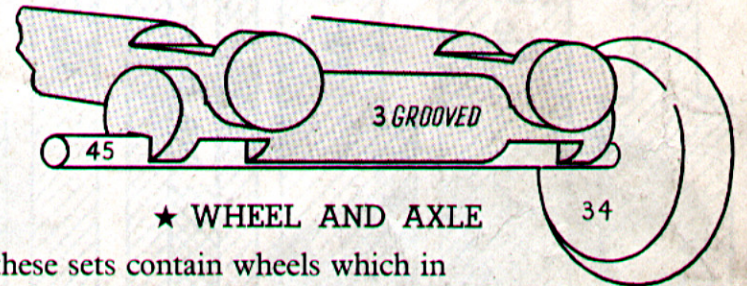

★ WHEEL AND AXLE

All of these sets contain wheels which in the early days were made from cross sections of Logs. Among the first things made with wheels were the wheelbarrow, hand truck and the ox cart. Later on man designed the wagon and the automobile. The grooved Logs No. 3 are used as bearings for the axle, No. 45, on the ends of which are placed the wheels, No. 34. These wheels are held securely to the axle by friction while the axle turns freely in the groove. Longer Logs are then placed in the notches of the No. 3 Logs to form the chassis on which the desired body may be constructed.

DIAGRAM OF PIECES—Actual Size

Because of lack of space, the following pieces are not illustrated: Nos. 14 and 15, the same length as No. 9 but having more notches; No. 17 with five pairs of notches; No. 22, the longest Timber, with six pairs of notches; No. 37, the gable; Nos. 41 and 42, the longest roof planks and No. 45, the axle.

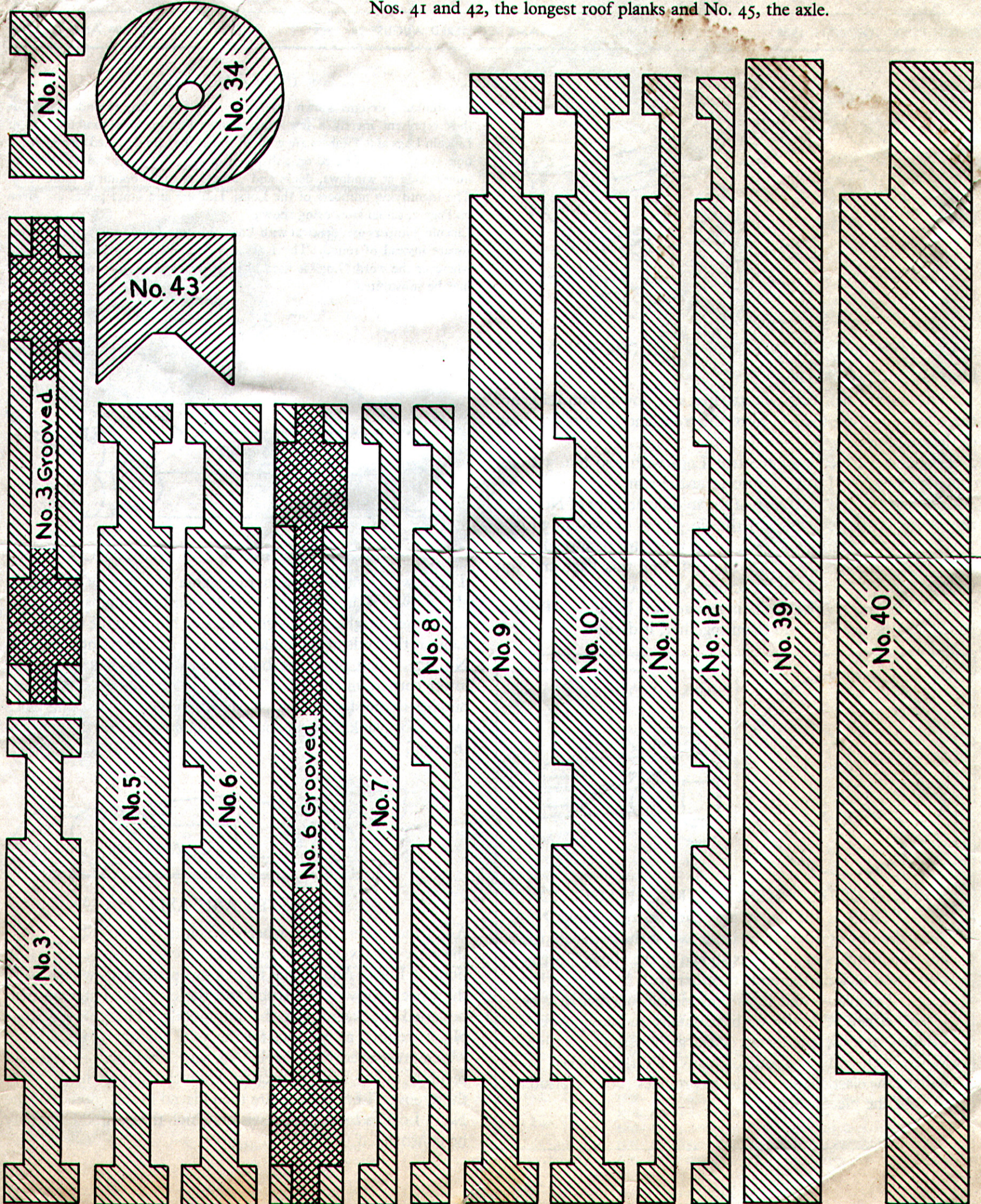

These Structures Can Be Made with the 1-L Set of Large Lincoln Logs

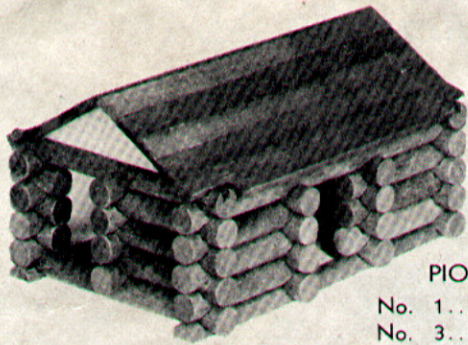

PIONEER CABIN

- | | |
|-------------|-------------|
| No. 1...29 | No. 6 Gr. 2 |
| No. 3...10 | No. 10... 2 |
| No. 3 Gr. 2 | No. 12... 2 |
| No. 5... 3 | No. 37... 2 |
| No. 6... 2 | No. 39... 8 |
| | No. 40... 2 |

CONTENTS OF 1-L SET	
No. 1...29	No. 34
No. 3...10	Wheels... 4
No. 3...2	No. 37
grooved	Gables... 2
No. 5...3	No. 39
No. 6...2	Roof Planks 8
grooved	No. 40
No. 6...2	Roof Planks 2
No. 10...2	No. 45
No. 12...2	Axles... 2
Total of 70 Pieces	

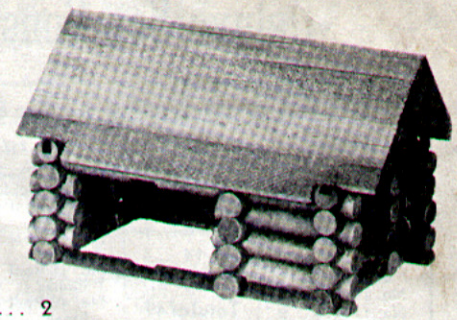

STORE—REAR

- | | |
|-------------|-------------|
| No. 1...29 | No. 10... 2 |
| No. 3... 9 | No. 12... 2 |
| No. 5... 3 | No. 37... 2 |
| No. 6... 2 | No. 39... 8 |
| No. 6 Gr. 2 | No. 40... 2 |

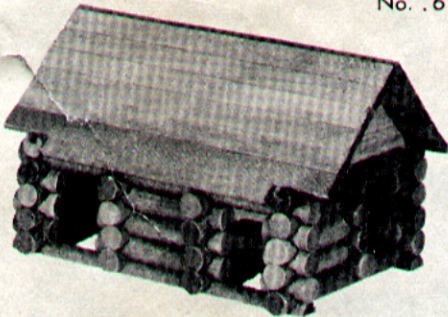

STORE—FRONT

- | | |
|-------------|-------------|
| No. 1...29 | No. 10... 2 |
| No. 3... 9 | No. 12... 2 |
| No. 5... 3 | No. 37... 2 |
| No. 6... 2 | No. 39... 8 |
| No. 6 Gr. 2 | No. 40... 2 |

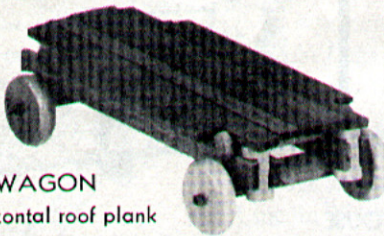

FLAT WAGON

Showing horizontal roof plank construction.

- | | |
|------------|-------------|
| No. 1... 4 | No. 34... 4 |
| No. 3... 2 | No. 39... 7 |
| No. 3 | No. 40... 2 |
| Gr.... 2 | No. 45... 2 |

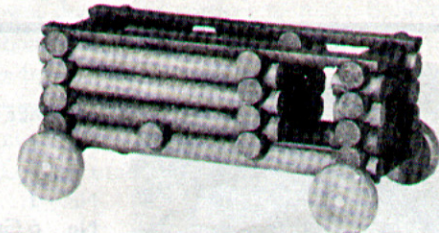

MILK TRUCK

- | |
|-------------|
| No. 1...18 |
| No. 3... 7 |
| No. 3 Gr. 2 |
| No. 5... 3 |
| No. 6... 2 |
| No. 6 Gr. 1 |
| No. 10... 2 |
| No. 12... 2 |
| No. 34... 4 |
| No. 45... 2 |

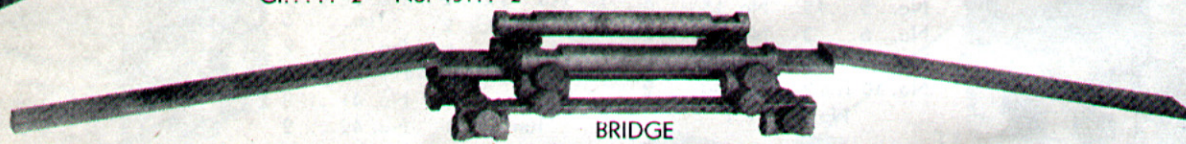

BRIDGE

- | | |
|------------|-------------|
| No. 1...20 | No. 5... 2 |
| No. 3... 2 | No. 12... 2 |
| | No. 39... 6 |

These Structures, Together with Those Shown Above, and Many Others Can Be Made with the 2-L Set of Large Lincoln Logs

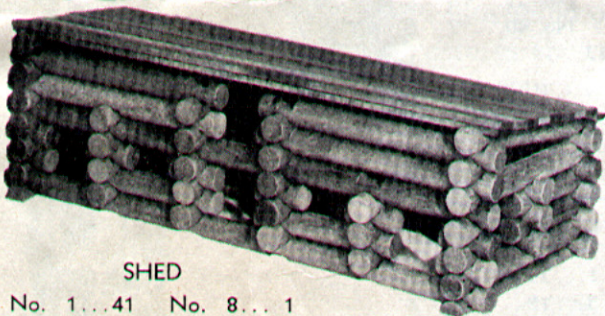

SHED

- | | |
|-------------|-------------|
| No. 1...41 | No. 8... 1 |
| No. 3... 4 | No. 9... 1 |
| No. 5... 8 | No. 10... 1 |
| No. 6... 2 | No. 22... 4 |
| No. 6 Gr. 2 | No. 37... 2 |
| No. 7... 1 | No. 41... 8 |
| | No. 42... 2 |

CONTENTS OF 2-L SET	
No. 1...52	No. 34
No. 3...10	Wheels... 4
No. 3...2	No. 37
grooved	Gables... 2
No. 5...9	No. 39
No. 6...2	Roof Planks 8
grooved	No. 40
No. 6...2	Roof Planks 2
No. 7...1	No. 41
No. 8...1	Roof Planks 8
No. 9...2	No. 42
No. 10...4	Roof Planks 2
No. 12...2	No. 43
No. 22...4	Chimney... 1
	No. 45
	Axles... 2
Total of 120 Pieces	

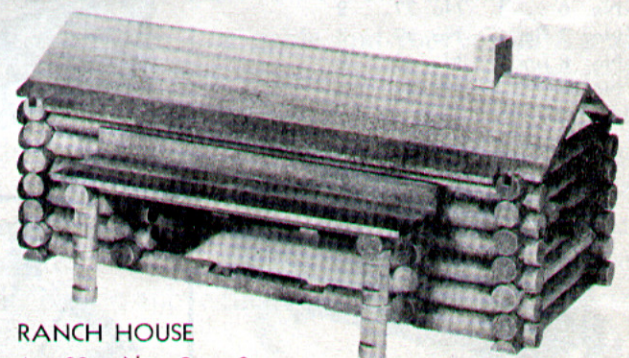

RANCH HOUSE

- | | |
|-------------|-------------|
| No. 1...39 | No. 9... 2 |
| No. 3...10 | No. 10... 3 |
| No. 3 Gr. 2 | No. 22... 4 |
| No. 5... 9 | No. 37... 2 |
| No. 6... 2 | No. 39... 4 |
| No. 6 Gr. 2 | No. 41... 8 |
| No. 7... 1 | No. 42... 2 |
| No. 8... 1 | No. 43... 1 |

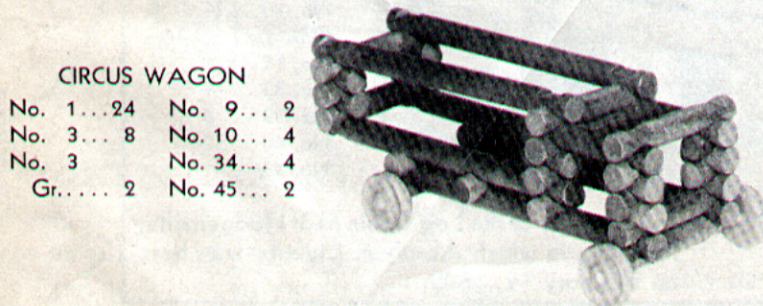

CIRCUS WAGON

- | | |
|------------|-------------|
| No. 1...24 | No. 9... 2 |
| No. 3... 8 | No. 10... 4 |
| No. 3 | No. 34... 4 |
| Gr.... 2 | No. 45... 2 |

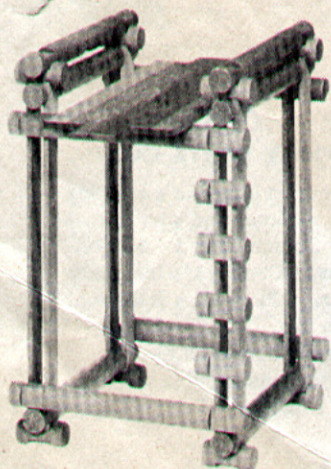

SETTLERS CABIN

- | | |
|-------------|-------------|
| No. 1...32 | No. 9... 2 |
| No. 3...10 | No. 10... 4 |
| No. 3 Gr. 2 | No. 12... 2 |
| No. 5... 9 | No. 37... 2 |
| No. 6... 2 | No. 39... 8 |
| No. 6 Gr. 2 | No. 40... 2 |
| | No. 43... 1 |

DIVING PLATFORM

Showing vertical roof plank construction.

- | | |
|------------|-------------|
| No. 1...16 | No. 39... 2 |
| No. 5... 8 | No. 40... 2 |
| No. 6... 2 | No. 41... 8 |

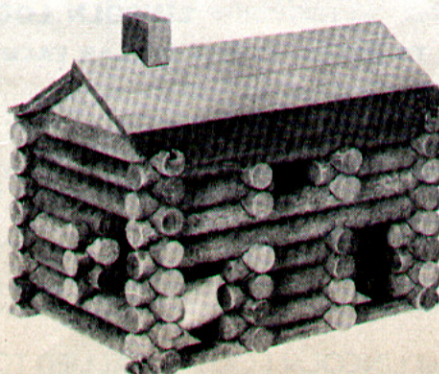

SCHOOL HOUSE

- | | |
|-------------|-------------|
| No. 1...43 | No. 9... 2 |
| No. 3...10 | No. 10... 2 |
| No. 3 Gr. 2 | No. 12... 2 |
| No. 5... 9 | No. 37... 2 |
| No. 6... 2 | No. 39... 8 |
| No. 6 Gr. 2 | No. 40... 2 |
| | No. 43... 1 |

All of These Structures, Together with Those Shown on Page 3, Can Be Made with the Deluxe Set, Consisting of Large Logs, Timbers and Metal Figures—No. 5-L-T-F

CONTENTS OF DELUXE SET (5-L-T-F)

TIMBERS	LOGS	MISC. PIECES	METAL FIGURES
No. 1.....65	No. 3...15	No. 34 Wheels... 4	1—Indian Archer Mounted
No. 3..... 2	No. 5...16	No. 37 Gables... 2	1—Indian Archer on Foot
No. 6..... 2	No. 6... 3	No. 39 Roof Planks... 8	2—Indian Gunners on Foot
No. 7..... 1	No. 9... 7	No. 40 Roof Planks... 2	1—Indian Crawling
No. 8..... 1	No. 14... 4	No. 41 Roof Planks... 8	2—Soldiers of 1812 on Foot
No. 10..... 4	No. 15... 2	No. 42 Roof Planks... 2	1—Pioneer
No. 11..... 2	Total of 47 Pieces	No. 43 Chimneys... 2	1—Horse
No. 12..... 2		No. 45 Axles... 2	1—Cow
No. 17..... 2		Mesh Bag... 1	1—Sheep
No. 22..... 6			2—Pigs
Total of 87 Pieces		Total of 31 Pieces	Total of 13 Pieces

Complete total of set, 178 Pieces

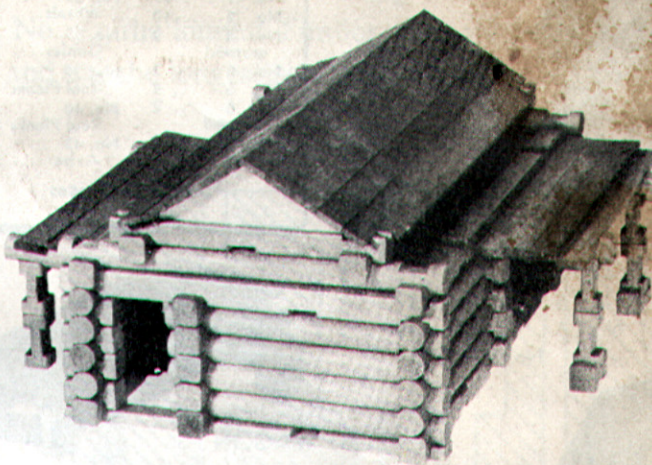

BUS TERMINAL

No. 1	No. 11
Tim.... 37	Tim.... 1
No. 3... 12	No. 12
No. 3	Tim.... 1
Gr. Tim. 2	No. 14... 2
No. 5... 8	No. 22
No. 6	Tim.... 6
Gr. Tim. 2	No. 37... 2
No. 9... 5	No. 39... 8
No. 10	No. 41... 8
Tim.... 1	No. 42... 2

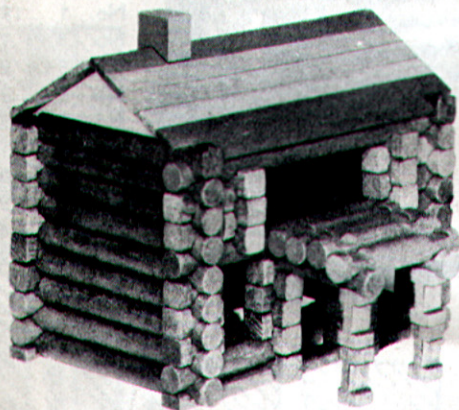

MEETING HOUSE

No. 1	No. 11
Tim.... 55	Tim.... 1
No. 3... 11	No. 12
No. 6 Gr. 2	Tim.... 1
No. 5... 15	No. 15... 2
No. 6... 3	No. 37... 2
No. 9... 2	No. 39... 8
No. 10 Tim. 2	No. 40... 2
	No. 43... 1

RAILWAY STATION

No. 1	No. 12
Tim.... 39	Tim.... 1
No. 3... 10	No. 14... 2
No. 3 Gr. 2	No. 22
No. 6 Gr. 2	Tim.... 6
No. 5... 8	No. 37... 2
No. 9... 5	No. 39... 4
No. 10	No. 41... 8
Tim.... 1	No. 42... 2
No. 11 Tim. 1	No. 43... 1

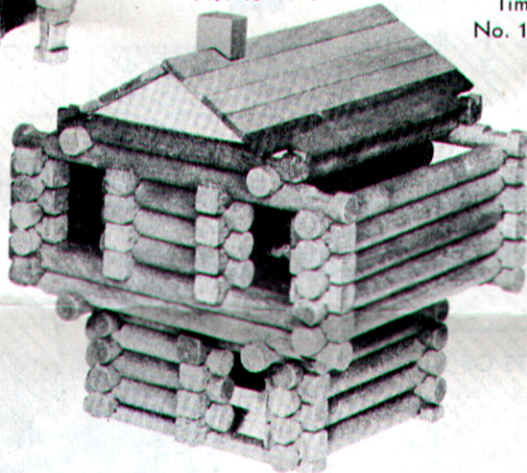
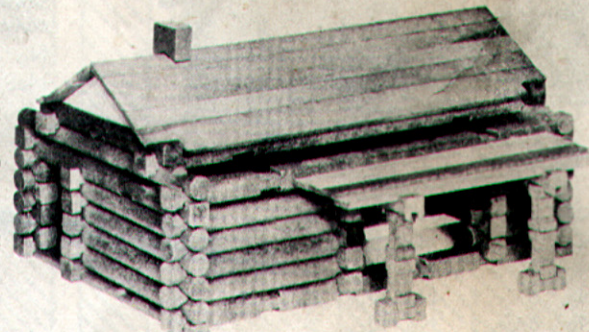

TWO STORY HOUSE

No. 1	No. 11
Tim.... 45	Tim.... 1
No. 3... 11	No. 12
No. 5... 11	Tim.... 1
No. 6... 2	No. 15... 1
No. 6 Gr. 2	No. 37... 2
No. 9... 3	No. 39... 8
No. 10 Tim. 4	No. 40... 2
	No. 43... 1

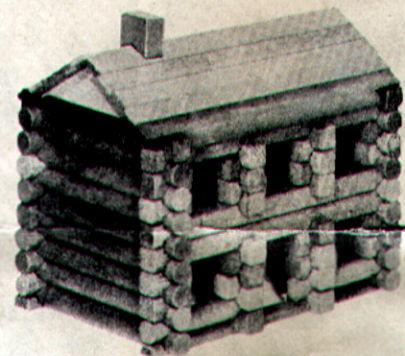

BLOCK HOUSE

No. 1 Tim. 42	No. 10
No. 3... 9	Tim.... 4
No. 6 Gr. 2	No. 14... 4
No. 5... 16	No. 15... 2
No. 6... 1	No. 37... 2
No. 7 Tim. 1	No. 39... 8
No. 8 Tim. 1	No. 40... 2
No. 9... 7	No. 43... 1

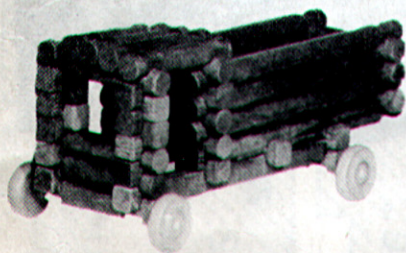

COAL TRUCK

No. 1... 22	No. 9... 6
No. 3... 13	No. 10... 4
No. 3	No. 34... 4
Gr.... 2	No. 45... 2

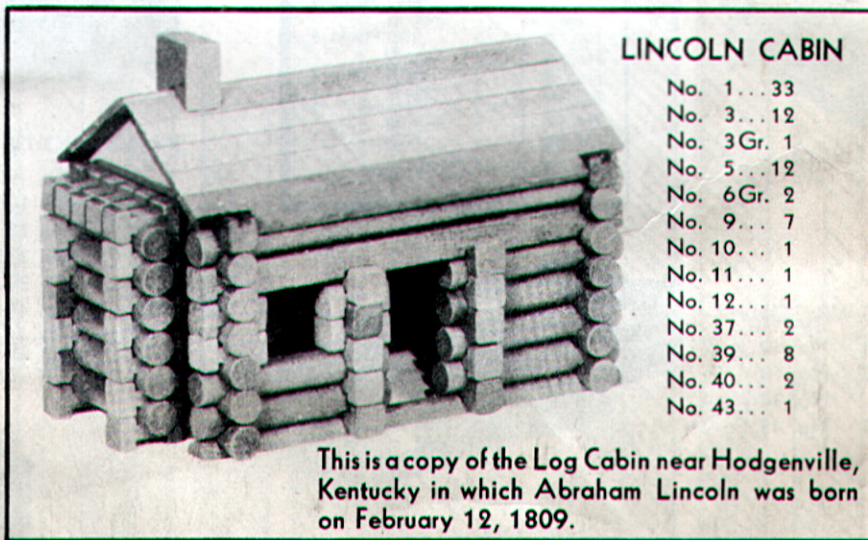

LINCOLN CABIN

No. 1... 33
No. 3... 12
No. 3 Gr. 1
No. 5... 12
No. 6 Gr. 2
No. 9... 7
No. 10... 1
No. 11... 1
No. 12... 1
No. 37... 2
No. 39... 8
No. 40... 2
No. 43... 1

This is a copy of the Log Cabin near Hodgenville, Kentucky in which Abraham Lincoln was born on February 12, 1809.

LOOKOUT TOWER

No. 1... 41
No. 3... 11
No. 3 Gr. 2
No. 41... 8



LINCOLN LOG Practically Unbreakable METAL FIGURES

SETS TO RETAIL AT ONE DOLLAR EACH

- NM-100—Indians**, 2 mounted, 8 on foot, 2 crawling.
- NM-101—Indians and Pioneers**, 10 Indians, 4 Pioneers.
- NM-102—Cowboys**, 2 mounted, 5 with rope, 5 shooting.
- NM-105—Cowboys and Indians**, 1 Cowboy mounted, 5 Cowboys shooting, 1 Indian mounted, 4 Indians on foot, 1 Indian crawling.
- NM-140—Farm Set with Trees**, 2 Trees, 2 Sheep, 4 Pigs, 1 Man, 1 Woman, 1 Horse, 1 Cow.
- NM-161—Tepees and Indians**, 2 cloth Tents with poles, 1 Indian mounted, 4 Indians on foot, 1 Indian crawling.

SETS TO RETAIL AT FIFTY CENTS EACH

- NM- 50—Indians**, 1 mounted, four on foot, and 1 crawling.
- NM- 53—Cowboys Shooting**, 1 mounted and 5 on foot.
- NM- 54—Cowboys with Rope**, 1 mounted and 5 on foot.
- NM- 55—Cowboys and Indians**, 4 Cowboys, 3 Indians.
- NM- 56—Indians and Pioneers**, 2 Pioneers, 5 Indians.
- NM- 57—Soldiers of 1812**, 6 on foot.
- NM- 58—Soldiers of 1776**, 1 mounted, four on foot.
- NM- 65—Royal Canadian Police**, 1 mounted, 4 on foot.
- NM- 70—Farm Set**, 1 Farmer, 1 Sheep, 1 Horse, 1 Cow, 2 Pigs.



Complete catalogue of LINCOLN LOGS and ALLIED TOYS will be gladly furnished on request
J. L. WRIGHT, INC., Merchandise Mart, Chicago, Illinois